



934-511

Lv7 2018-r1

Modelo-model:

Kit soportes LCV

Lote-Lot-Lot-Lot:

01-18

Peso-Weight-Poids-Gewicht:

4,52 kg

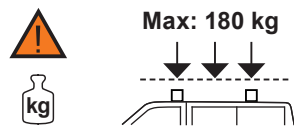
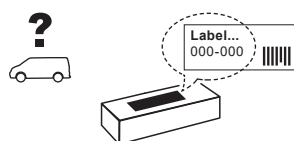

Código Homologación CEE
EEC Type Approval Number

E9 26 R- 03 3022

E9 26 R- 03 3024



CITY CRASH (✓)
According to ISO/ P. AS 11154:2006

CRUZBER SA
ES-A14018311
P.I. Las Salinas II
14960 - Rute - Spain
www.cruzber.com

(E)	Instrucción de montaje ¡Leer primero!	Kit fijación
(GB)	Assembly instructions Read first!	Fixation Kit
(F)	Instruction de montage Lire en premier!	Kit fixation
(D)	Montageanleitung Zuerst lesen!	Stützfuß-Kit
(PT)	Instruções de montagem Ler primeiro!	Kit fixação
(PL)	Instrukcja montażu Najpierw przeczytaj!	Element mocujący
(CZ)	Montážní návod Čtěte pozorně!	Fixační kit
(HU)	Szerelési Utasítás Először olvassd el!	Rögzítő készlet
(RO)	Instructiuni de montaj Intai cititi!	Kit de fixare
(HR)	Detaljne upute Prvo pročitati!	Kit za montažu
(GR)	Διαβάστε προσεκτικά τις Οδηγίες Συναρμολόγησης!	Κιβώτιο (Kit) Επισκευής
(TR)	Öncelikle montaj: Talimatlarını okuyunuz!	Montaj kiti
(RU)	Инструкции по монтажу Сначала прочитайте!	Крепежный комплект
(I)	Istruzioni di montaggio Leggere per primo!	Kit di fissaggio
(NL)	Montagehandleiding Eerst lezen!	Bevestigingsset
(SLO)	Navodila za sestavljanje Preberite!	Kit za pričvrstitev



1.



(E) Contenido embalaje: ¡Verificar!

(GB) Package content: Check!

(F) Contenu d'emballage: Vérifier!

(D) Packungsinhalt: Überprüfen!

(PT) Contéudo embalagem:
Verificar!

(PL) Zawartość opakowania:
sprawdź!

(CZ) Obsah balení: Zkontrolujte!

(HU) Csomag tartalma: Ellenőrizd!

(RO) Pachetul contine: Verificati!

(HR) Sadržaj paketa: Provjeri!

(GR) Ελέγξτε το περιεχόμενο του
πακέτου!

(TR) Paket içeriğini: Control ediniz!

(RU) Содержание упаковки:
Проверьте!

(I) Contenuto della confezione:
Controllare!

(NL) Pakket inhoud: Controleer!

(SLO) Vsebina paketa: Preverite!

x1



x8

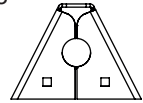

(500)

x8

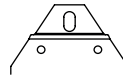

4x (851)

2x (852)

2x (853)

x8

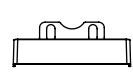

6x (012-232)

2x (012-234)

x8

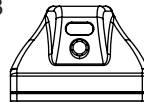

(813-074)

x2



(012-100)

x2



1x (810-144)

1x (810-182)

2. 



35x35 mm



52x35 mm
Aluminium



pág. 3,4,5,6,7,8



pág. 3,4,5,9,10,11,12



pág. 3,4,5,13,14,15,16

3. 

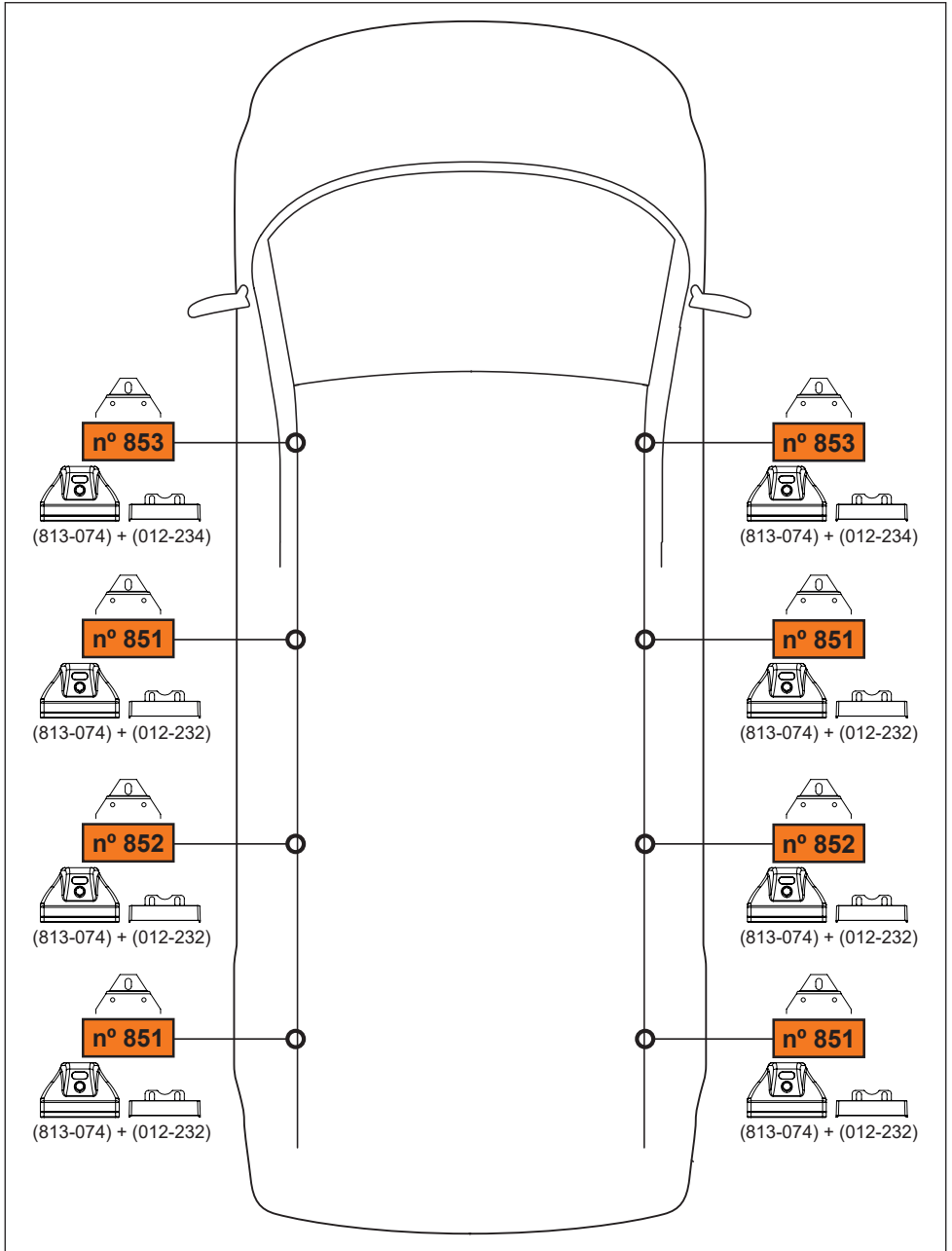

4. 

n° 853

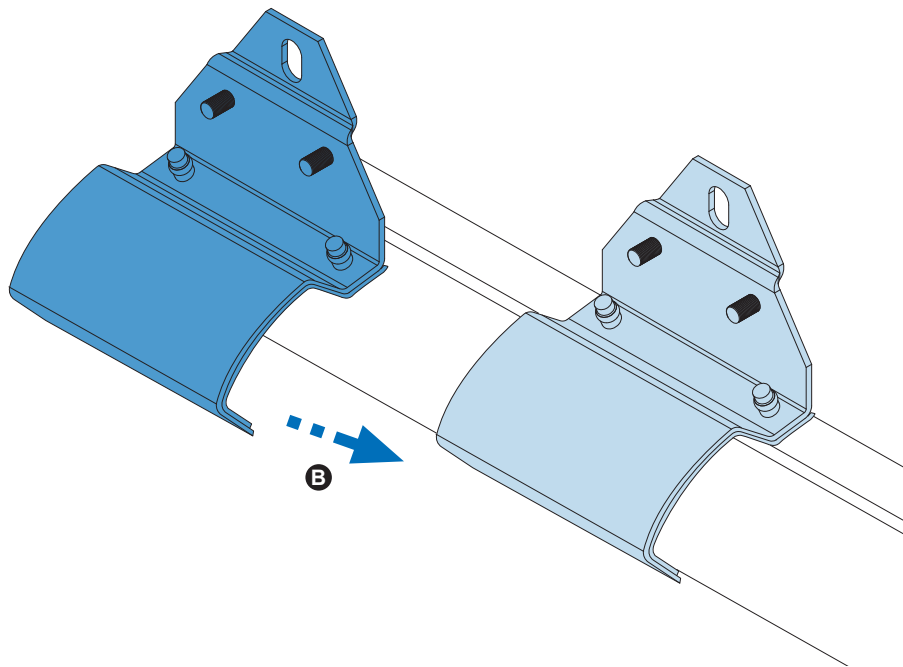
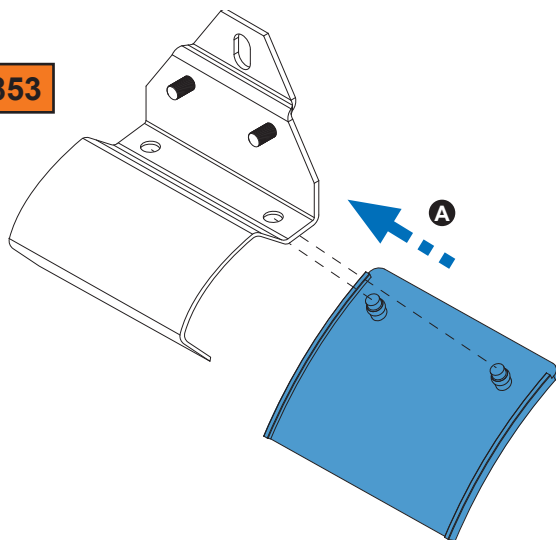

5. 

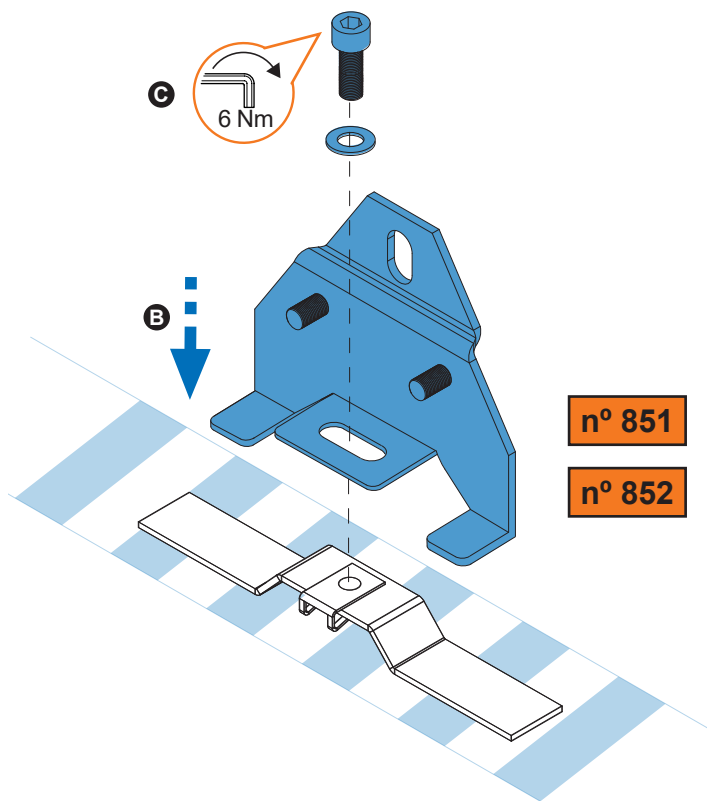
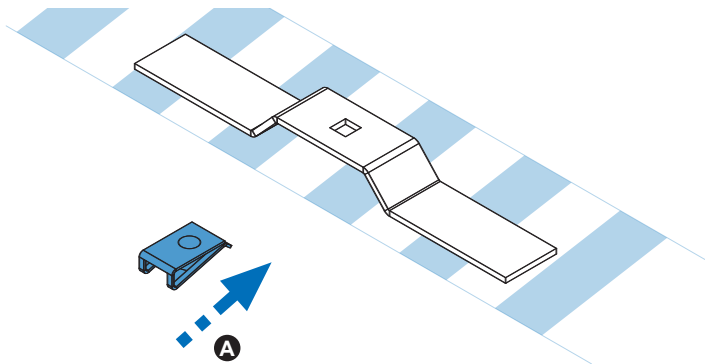

6. 

35x35 mm

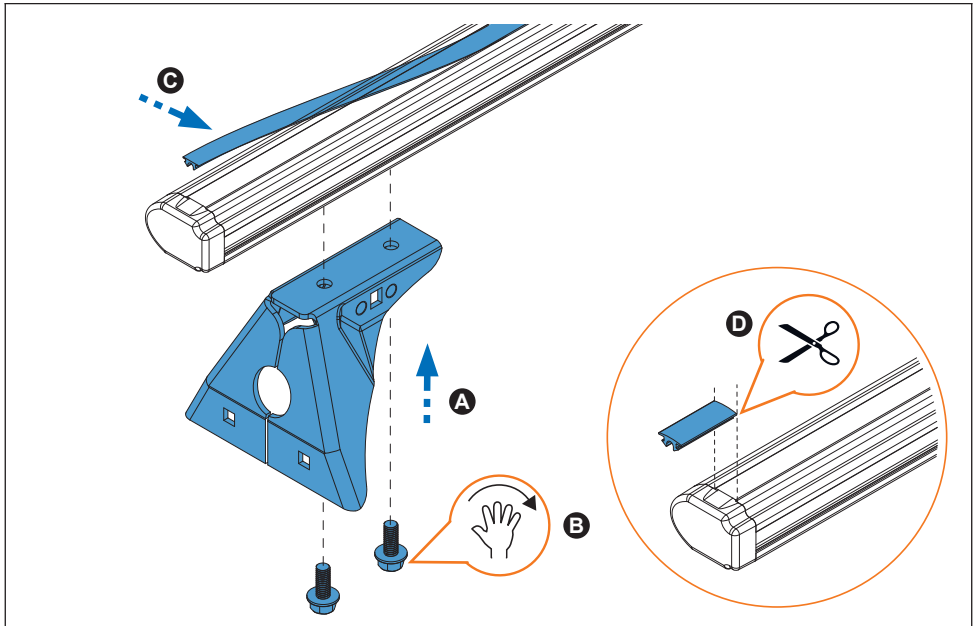
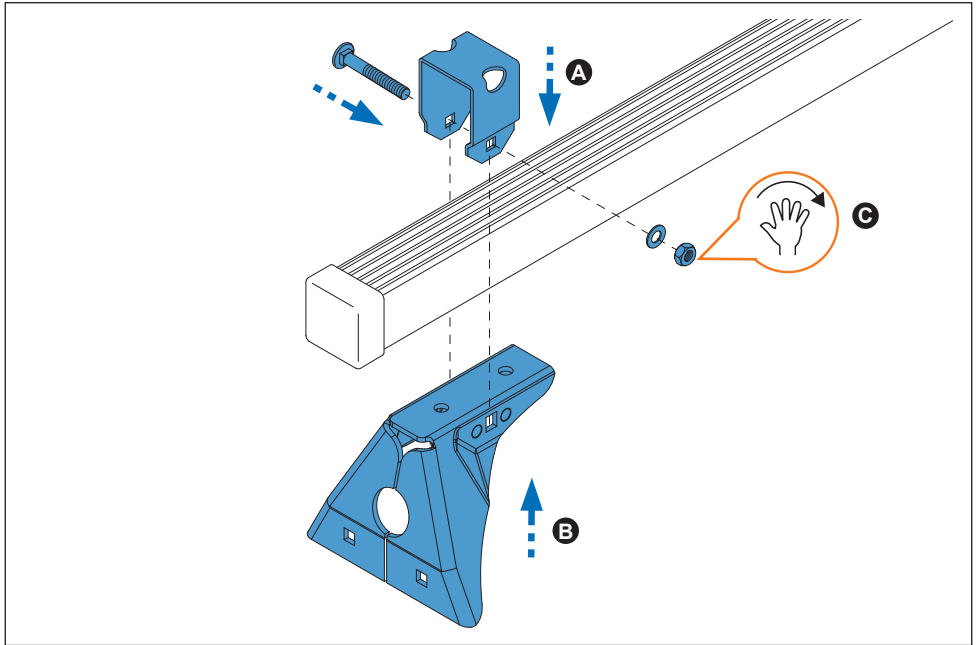

52x35 mm
Aluminium



7. 

35x35 mm

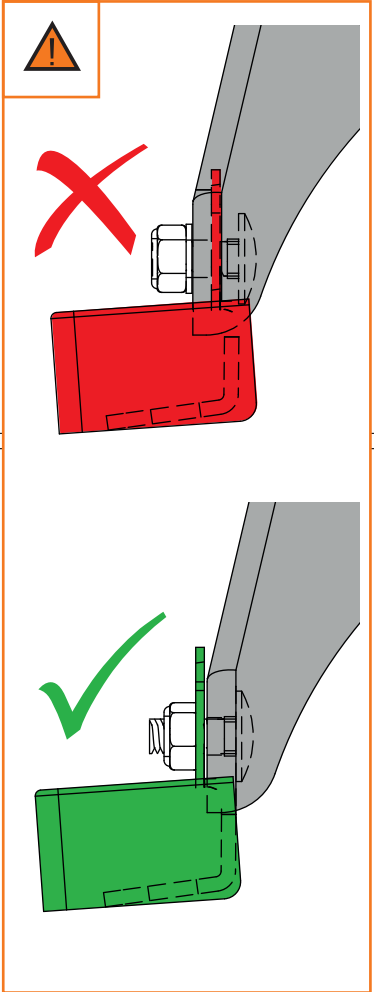
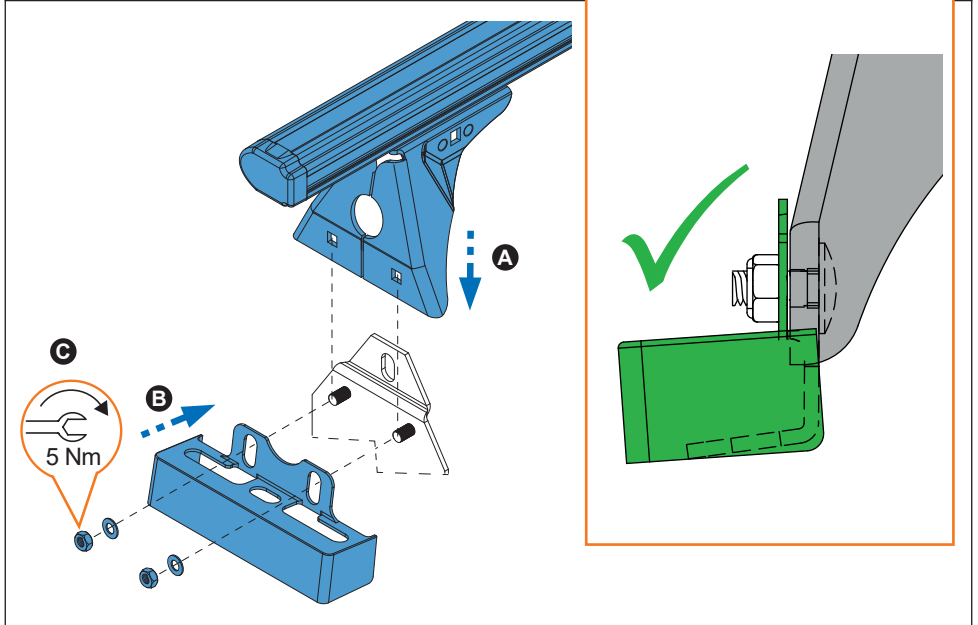
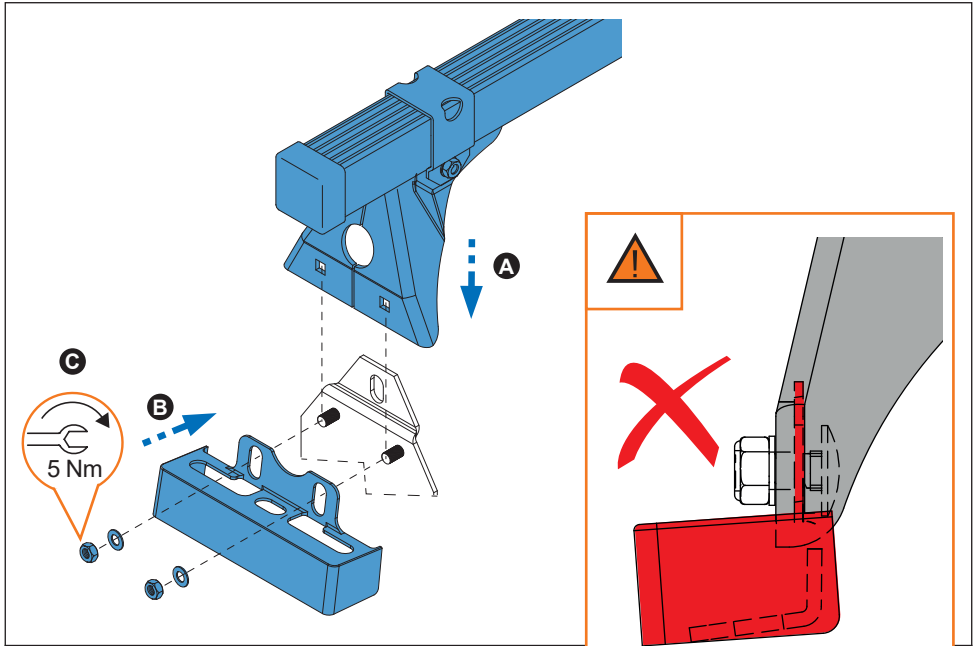

52x35 mm
Aluminium



8. 

35x35 mm

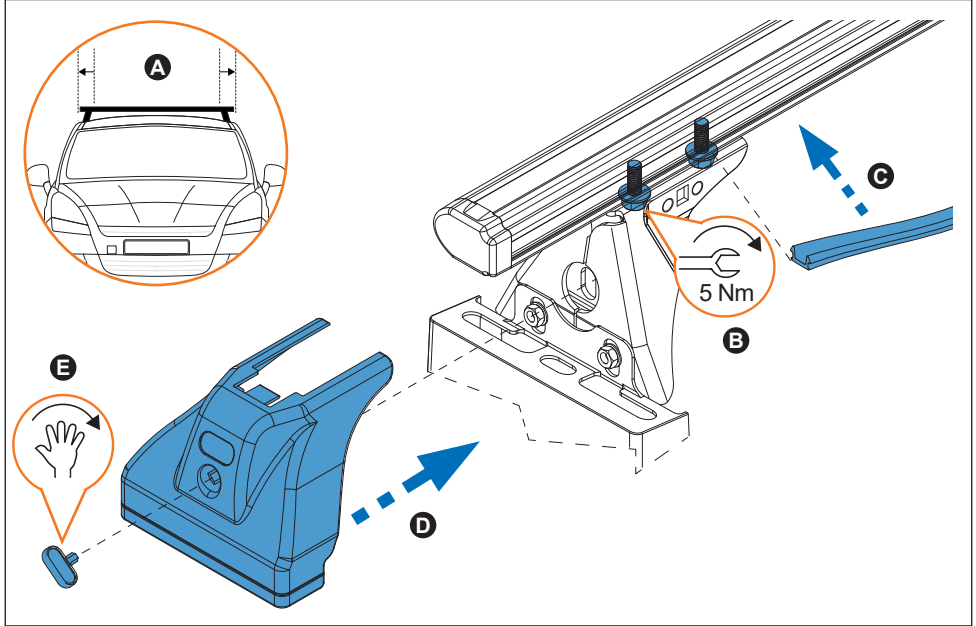
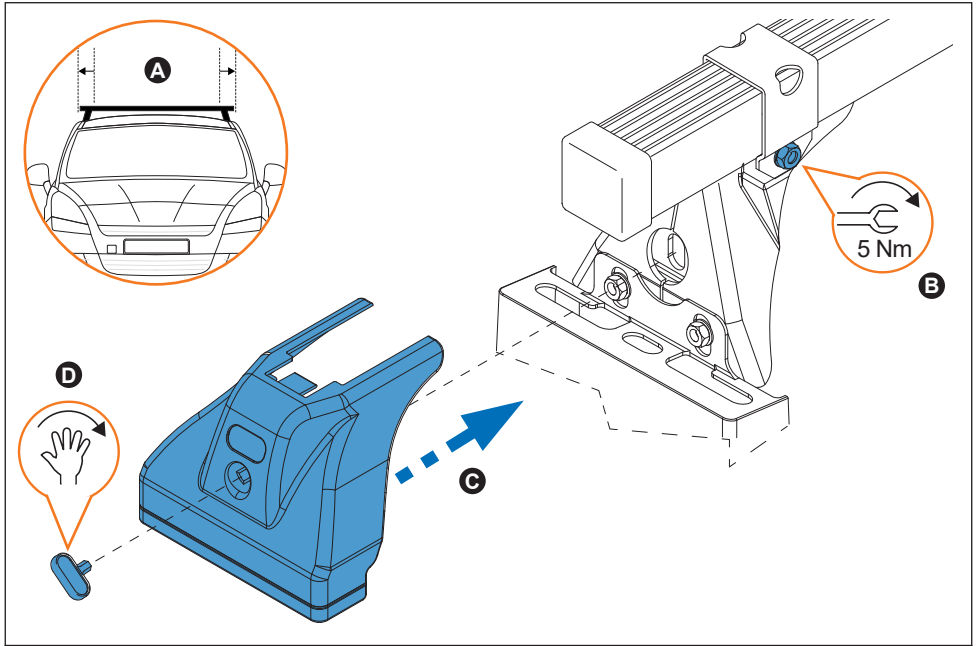

52x35 mm
Aluminium

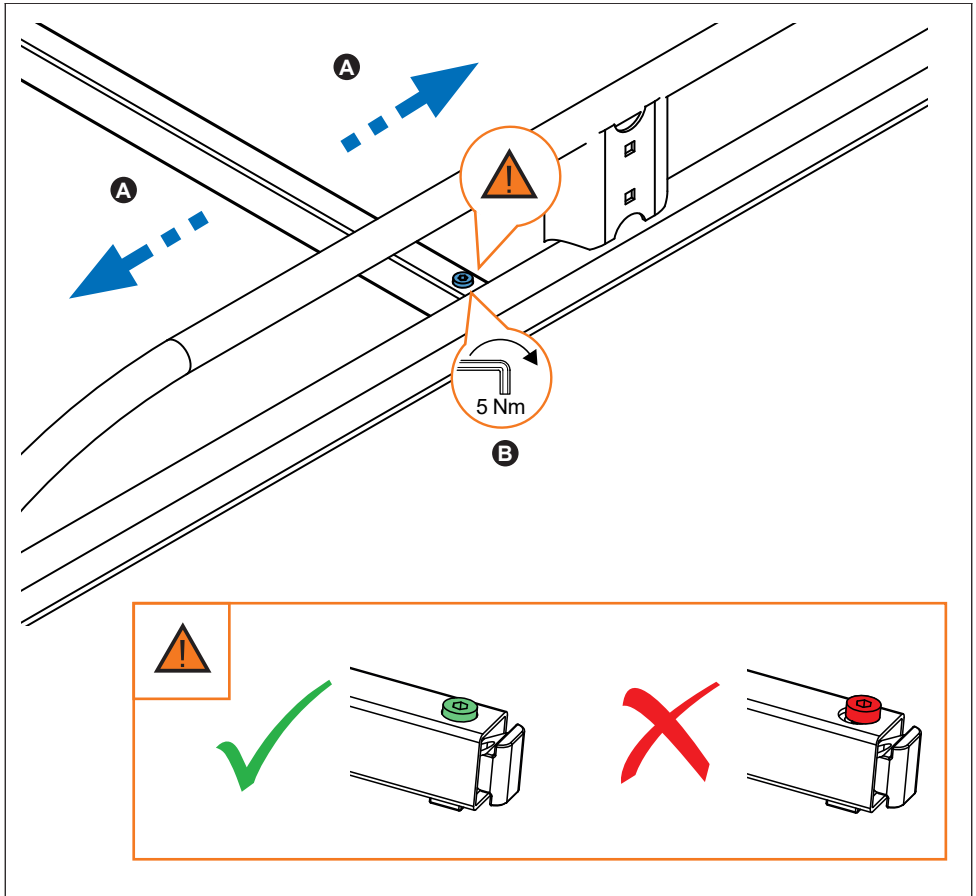
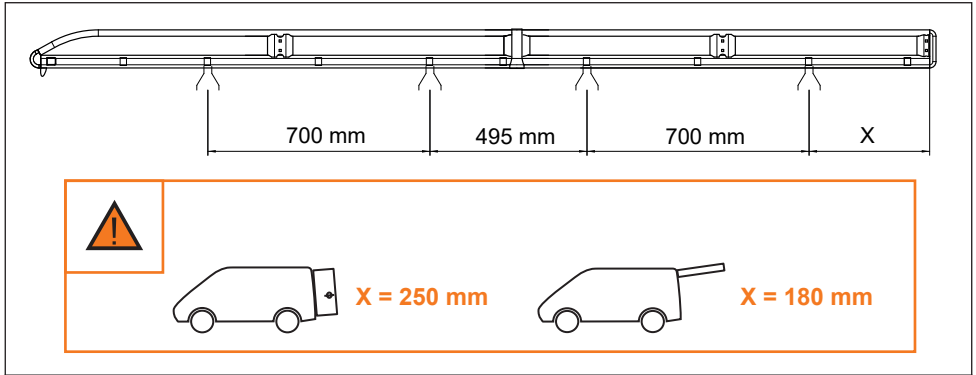

9. 

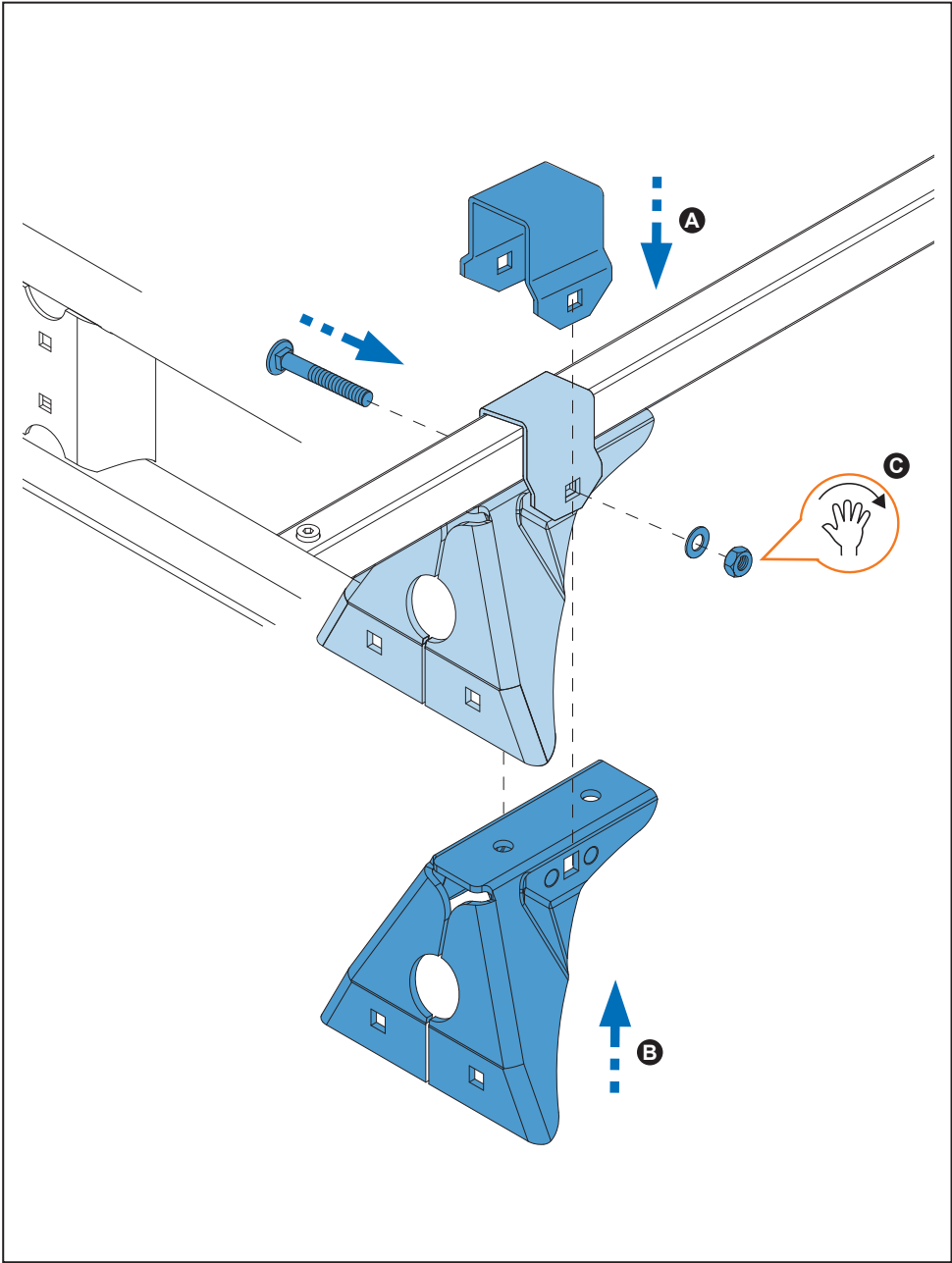

10.



11.

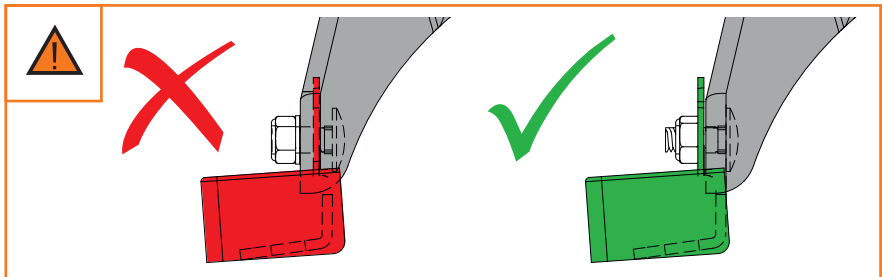
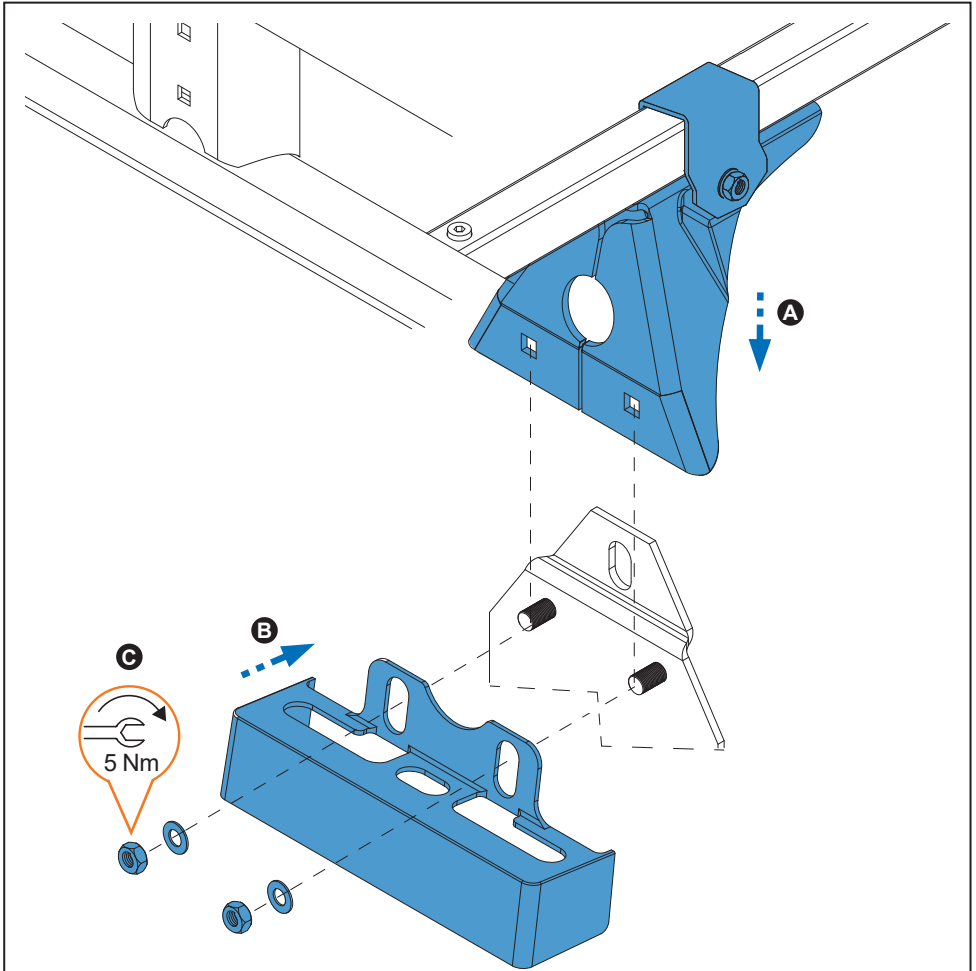

12.

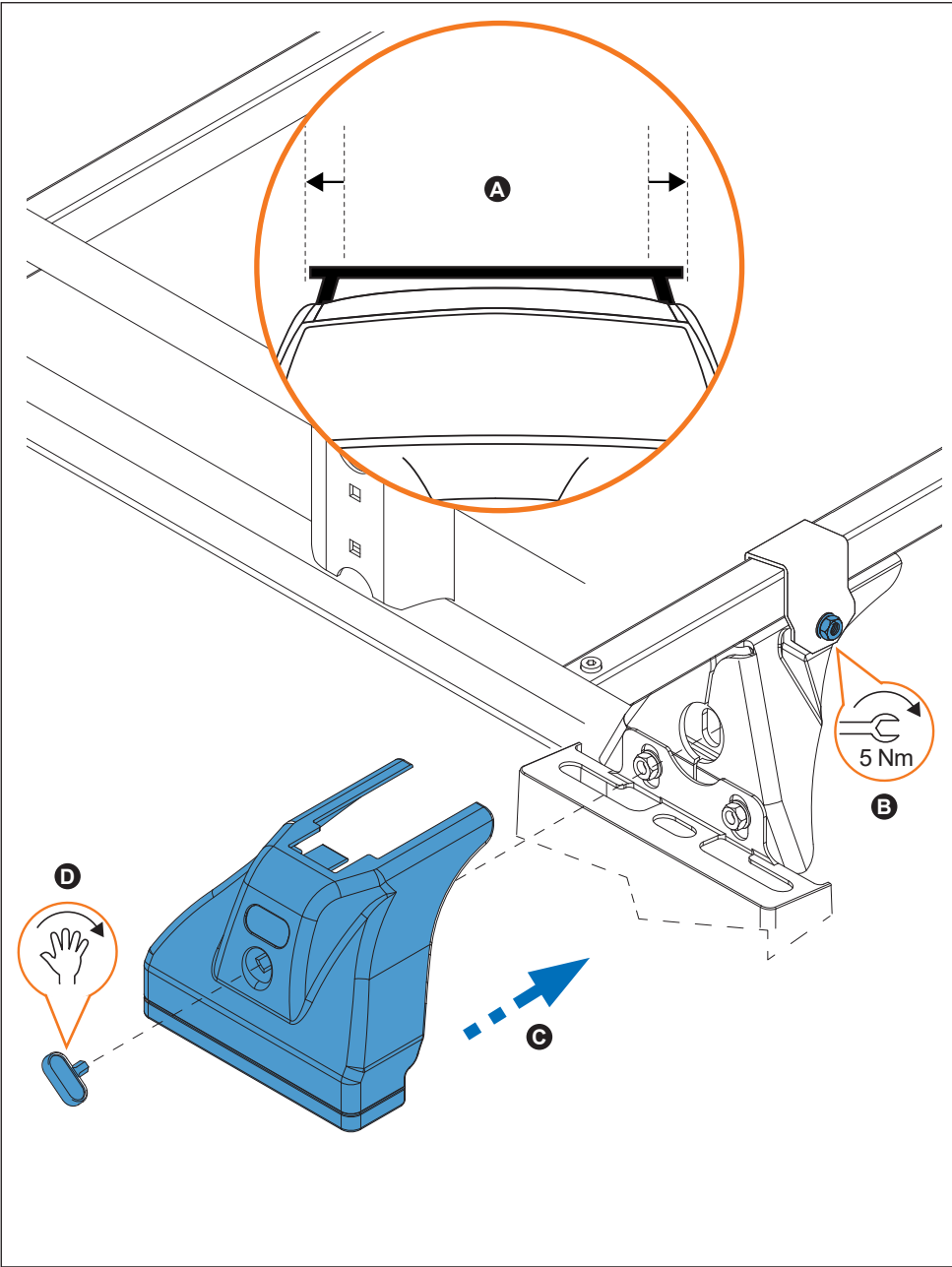

13.

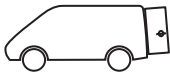
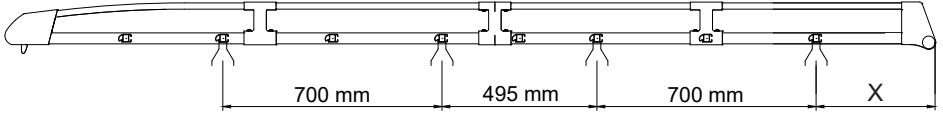
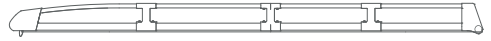

X = 350 mm

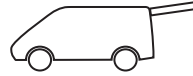

X = 180 mm

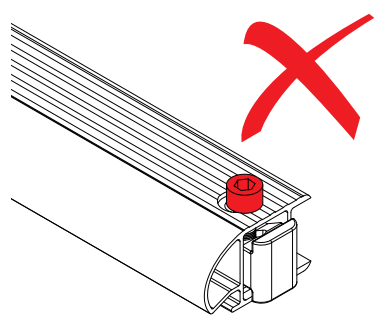
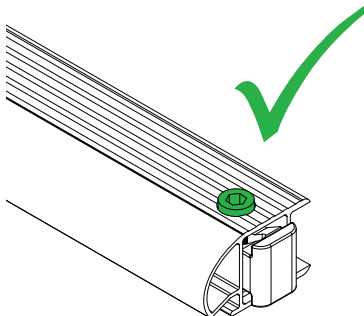
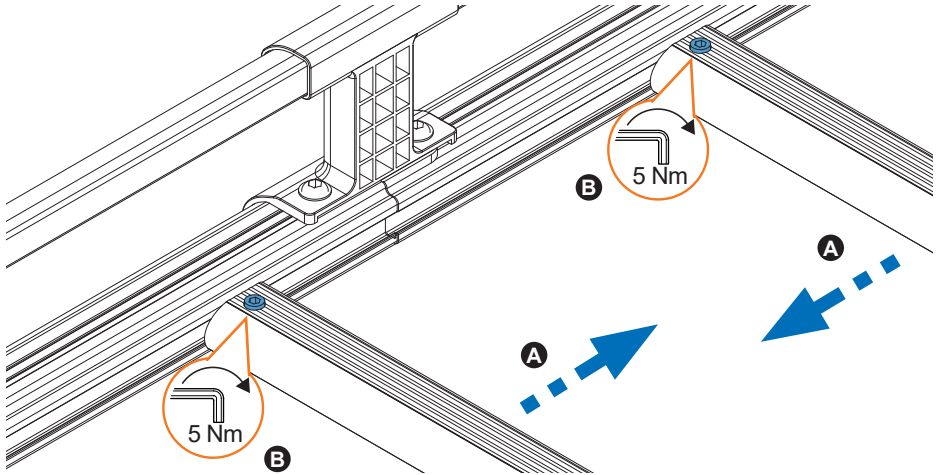

14.

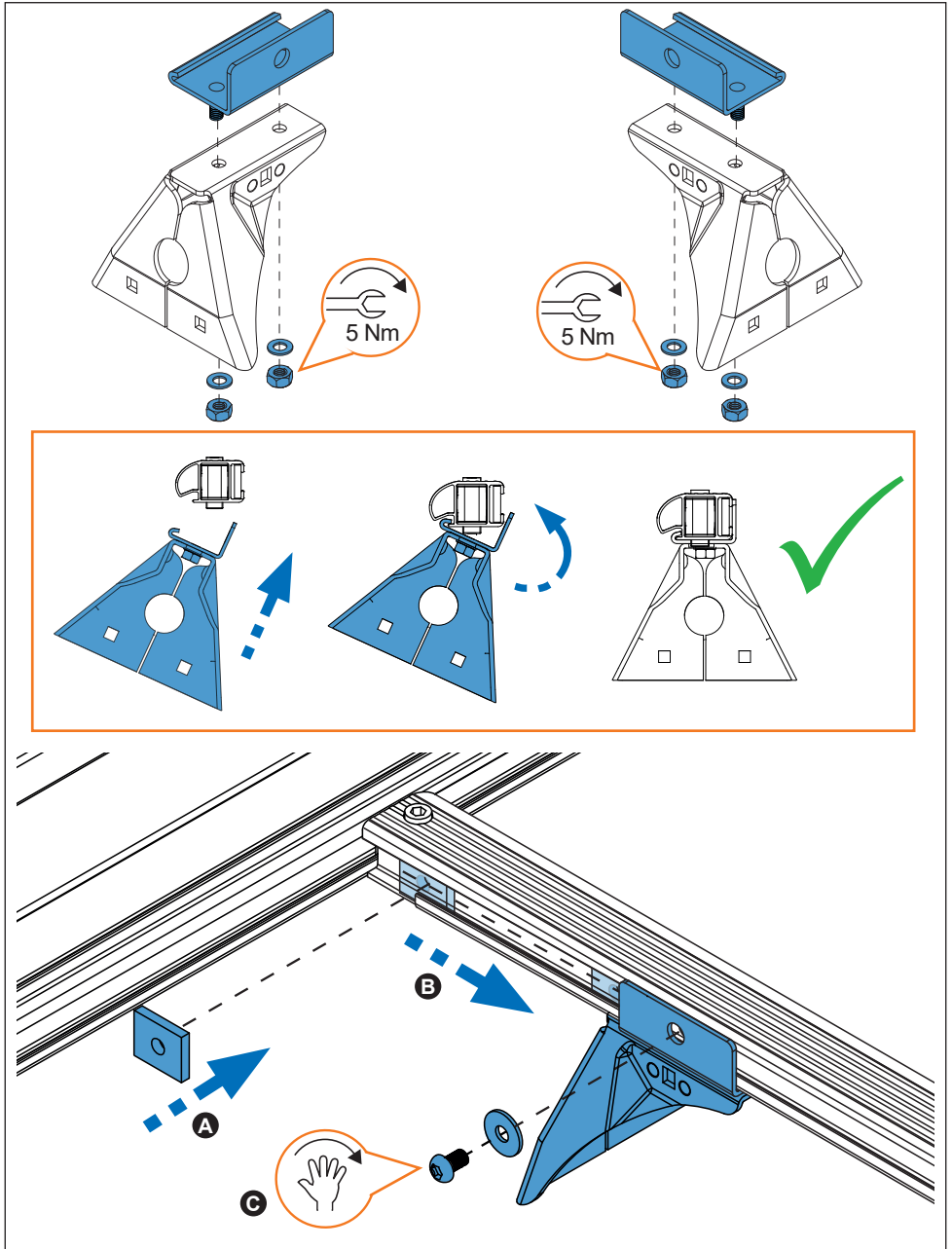

15.

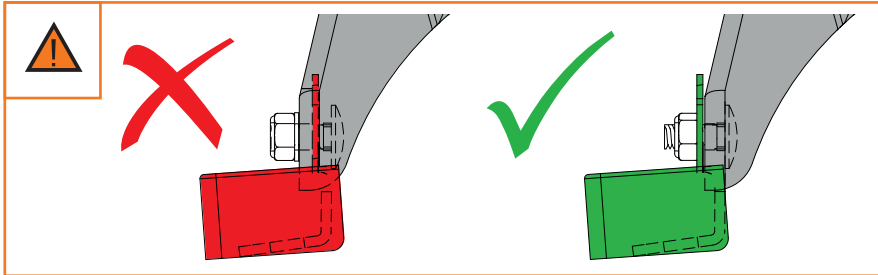
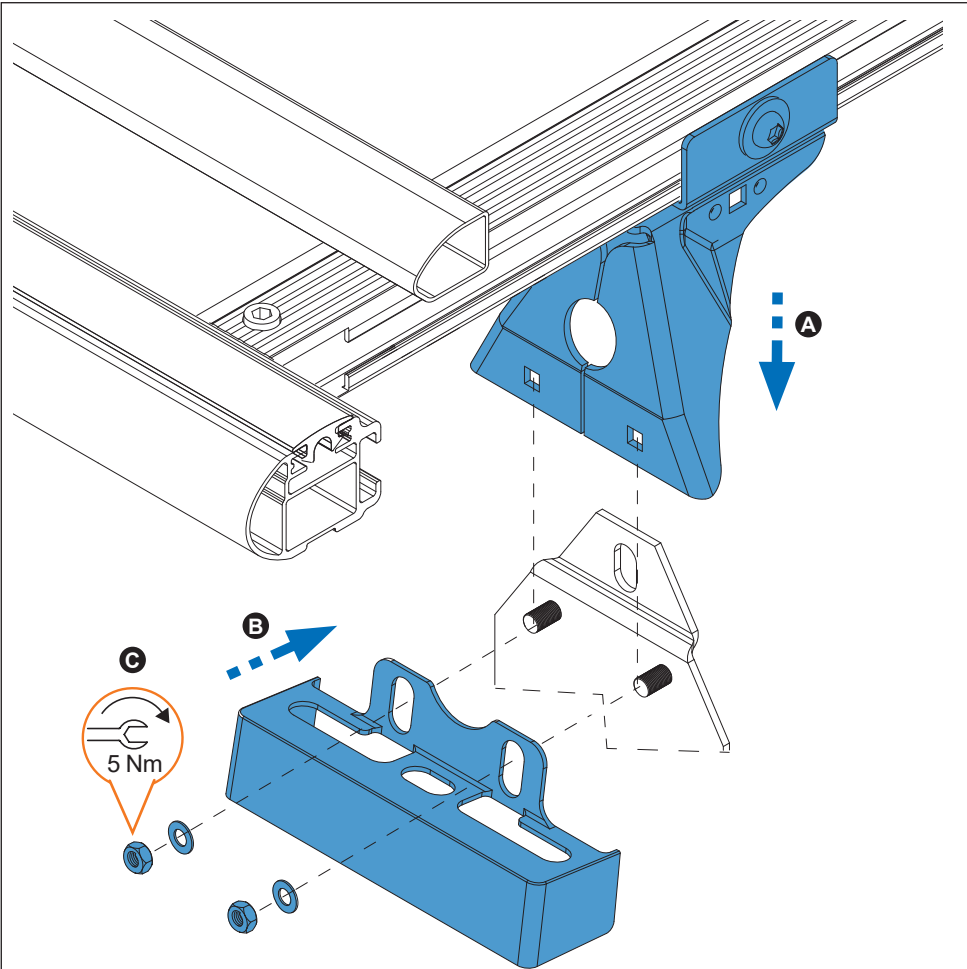

16.

