



Cruzber S.A., ES-A14018311
P.I. Las Salinas II, E-14960 Rute
www.cruzber.com

Código
Code
Code
Kode

935-671

Lv 7 2015 - r2

Modelo
Model
Modèle
Modell

Lote	01 -14	Peso	0,96 kg
Lot		Weight	
Lot		Poids	
Lot		Gewicht	



Kit tipo **A**
Kit type
Kit type
Kit Typ

Código Homologación ECE R26.03
R 26.03 ECE Type Approval Number

E9-26R-03.3015

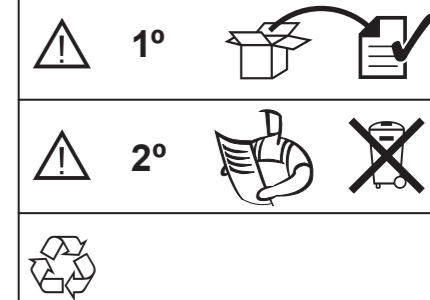

Kit fijación

Fixation Kit

Kit fixation

Stützfuß-Kit

Kit fixação

Element mocujący

Fixační kit

Rögzítő készlet

Kit de fixare

Kit za montažu

Κιβώτιο (Kit) Επισκευής

Montaj kiti

Крепежный комплект

Kit di fissaggio

Bevestigingsset

Kit za pričvrstitev

(E) Instrucción de montaje
¡Leer primero!

(GB) Assembly instructions
Read first!

(F) Instruction de montage
Lire en premier!

(D) Montageanleitung
Zuerst lesen!

(PT) Instruções de montagem
Ler primeiro!

(PL) Instrukcja montażu
Najpierw przeczytaj!

(CZ) Montážní návod
Čtěte pozorně!

(HU) Szerelési Utasítás
Először olvasd el!

(RO) Instrucțiuni de montaj
Intai cititi!

(HR) Detaljne upute
Prvo pročitati!

(GR) Διαβάστε προσεκτικά τις
Οδηγίες Συναρμολόγησης!

(TR) Öncelikle montaj:
Talimatlarını okuyunuz!

(RU) Инструкции по монтажу
Сначала прочитайте!

(IT) Istruzioni di montaggio
Leggere per primo!

(NL) Montagehandleiding
Eerst lezen!

(SLO) Navodila za sestavljanje
Preberite!

(E) Contenido embalaje: ¡Verificar!

(GB) Package content: Check!

(F) Contenu d'emballage: Vérifier!

(D) Packungsinhalt: Überprüfen!

(PT) Contéudo embalagem: Verificar!

(PL) Zawartość opakowania: sprawdź!

(CZ) Obsah balení: Zkontrolujte!

(HU) Csomag tartalma: Ellenőrizd!

(RO) Pachetul contine: Verificati!

(HR) Sadržaj paketa: Provjeri!

(GR) Ελέγξτε το περιεχόμενο: του πακέτου!

(TR) Paket içeriğini: Control ediniz!

(RU) Содержание упаковки: Проверьте!

(IT) Contenuto della confezione: Controllare!

(NL) Pakket inhoud: Controleer!

(SLO) Vsebina paketa: Preverite!

x 1 	x 1 	x 1 (018-041)	x 1 (810-045)
x 4 1x (704-1857) 1x (704-1858) 1x (704-1859) 1x (704-1860)	x 4 2x (012-080) 2x (012-100)	x 1 (001-820)	



Importante!
Important!
Important!
Wichtig!

- E** ¡Este Kit de fijación tiene que usarse con sistemas portacargas Cruz!
- GB** This fixation Kit must be used with Cruz roof rack systems!
- F** Cet Kit de fixation devra être utilisé avec les systèmes porte-charge Cruz!
- D** Dieser Stützfuß-Kit muß mit Cruz Dachträgersystemen benutzt werden!
- PT** Este Kit de fixação deve ser utilizado com os sistemas porta cargas Cruz!
- PL** Niniejszy element mocujący musi być używany z systemami bagażników dachowych firmy Cruz!
- CZ** Tento fixační kit musí být používán s nosným systémem Cruz!
- HU** Ez a rögzítő készlet csak a Cruz rendszerekkel használható!
- RO** Acest Kit de fixare, trebuie utilizat cu sisteme Cruz!
- HR** Kit za montažu mora biti korišten uz Cruz sistem krovnog nosača!
- GR** Το αξεσουάρ αυτό θα πρέπει να χρησιμοποιείται αποκλειστικά στα συστήματα μπαρών της Cruz!
- TR** Bu aksesuar mutlaka Cruz taşıma sistemleriyle kullanılmalıdır!
- RU** Крепежный комплект должен быть использован с багажной системой на крышу марки Cruz!
- IT** Questo kit di fissaggio deve essere usato con i portapacchi CRUZ
- NL** Deze bevestigingsset moet worden gebruikt in combinatie met Cruz dakdrager systeem!
- SLO** Kit za pričvrstitev naj se uporablja le z izdelki iz asortimana strešnih košar CRUZ!

